

[Twin Turbo Series](#)

TUHB-V88G-930-Q(M)



More Information



**Specifications**

<b>Mounting</b>	Panel Mount with Volume Control
<b>Color</b>	Green
<b>Operating Mode</b>	Extra Loud Medium Beep Tone
<b>Operating Voltage</b>	9-30 Vdc
<b>Operating Frequency</b>	3000±250 Hz
<b>Typical Operating Current</b>	65 mA at 9 Vdc 125 mA at 30 Vdc
<b>Typical Sound Pressure</b>	85 ±5 dB(A) at 9 Vdc at 24 inches (61 cm), at 25°C 103 ±5 dB(A) at 30 Vdc at 24 inches (61 cm), at 25°C
<b>Termination</b>	Quick Connect Blades
<b>Termination Strength</b>	Pull test with a maximum of 22 pounds (10 kg) load
<b>Operating Temperature</b>	-20_C to +65_C
<b>Storage Temperature</b>	-40_C to +85_C
<b>Surge Voltage</b>	20% over maximum rated voltage for less than 5 minutes
<b>Reverse Voltage Protection</b>	To the maximum operating voltage
<b>Construction Materials</b>	Lens/Case- Green Translucent Polycarbonate 94 VO Potting- 2 parts epoxy resin or silicone, black
<b>Gasket</b>	Gasket (Included) 0.125" thick, 60 Durometer Neoprene ASTM B117 Certified - Withstands exposure to salt spray for 300 hours IP 68 Certified - Withstands water submergence and dust exposure
<b>Construction Materials</b>	Humidity- 95% relative humidity at +40_C continuously for 100 hours. Vibration- Withstands vibration between 0 and 55 Hz. on all axes.
<b>Life Expectancy</b>	79 years under normal operating conditions.
<b>Warranty</b>	For a period of two years from the date of manufacture under normal operating conditions.
<b>Notes</b>	This product is not intended as a life safety device.
<b>Terms and Conditions of Sale</b>	<a href="#">Link here</a>

Dimensions

BACK



RING



GASKET

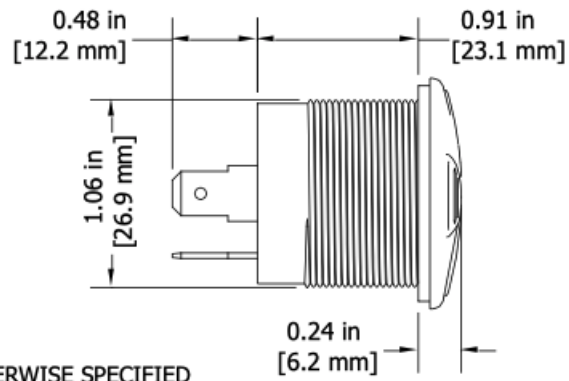

SIDE

FRONT



TOLERANCES ARE  $\pm 0.03$  in [ $\pm 0.76$  mm] UNLESS OTHERWISE SPECIFIED