

[Twin Turbo Series](#)

TUHC-88W-930-Q



More Information

 RoHS Compliant

Specifications

| | |
|-------------------------------------|--|
| Mounting | Panel Mount |
| Color | White |
| Operating Mode | Extra Loud Continuous Tone |
| Operating Voltage | 9-30 Vdc |
| Operating Frequency | 3000±250 Hz |
| Typical Operating Current | 65 mA at 9 Vdc 125 mA at 30 Vdc |
| Typical Sound Pressure | 85 ±5 dB(A) at 9 Vdc at 24 inches (61 cm), at 25°C 103 ±5 dB(A) at 30 Vdc at 24 inches (61 cm), at 25°C |
| Termination | Quick Connect Blades |
| Termination Strength | Pull test with a maximum of 22 pounds (10 kg) load |
| Operating Temperature | -20_C to +65_C |
| Storage Temperature | -40_C to +85_C |
| Surge Voltage | 20% over maximum rated voltage for less than 5 minutes |
| Reverse Voltage Protection | To the maximum operating voltage |
| Construction Materials | Lens/Case- White Translucent Polycarbonate 94 VO Potting- 2 parts epoxy resin or silicone, black |
| Gasket | Gasket (Included) 0.125" thick, 60 Durometer Neoprene ASTM B117 Certified - Withstands exposure to salt spray for 300 hours IP 68 Certified - Withstands water submergence and dust exposure |
| Construction Materials | Humidity- 95% relative humidity at +40_C continuously for 100 hours. Vibration- Withstands vibration between 0 and 55 Hz. on all axes. |
| Life Expectancy | 43 years under normal operating conditions. |
| Warranty | For a period of two years from the date of manufacture under normal operating conditions. |
| Notes | This product is not intended as a life safety device. |
| Terms and Conditions of Sale | Link here |

Dimensions

BACK

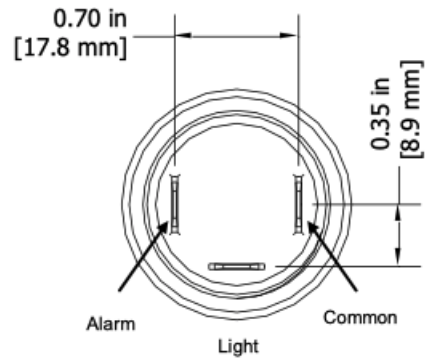

RING



GASKET



SIDE

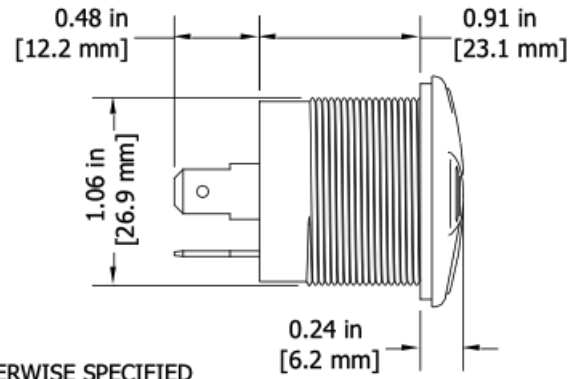

FRONT

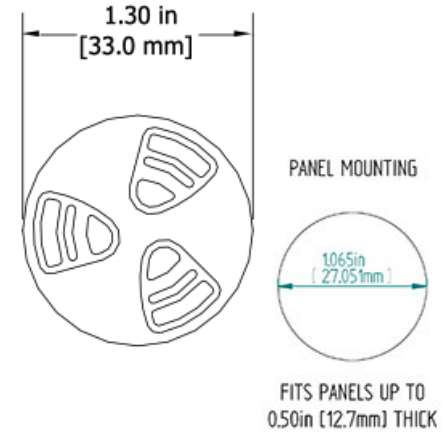

TOLERANCES ARE ± 0.03 in [± 0.76 mm] UNLESS OTHERWISE SPECIFIED